

12/2011 - V2

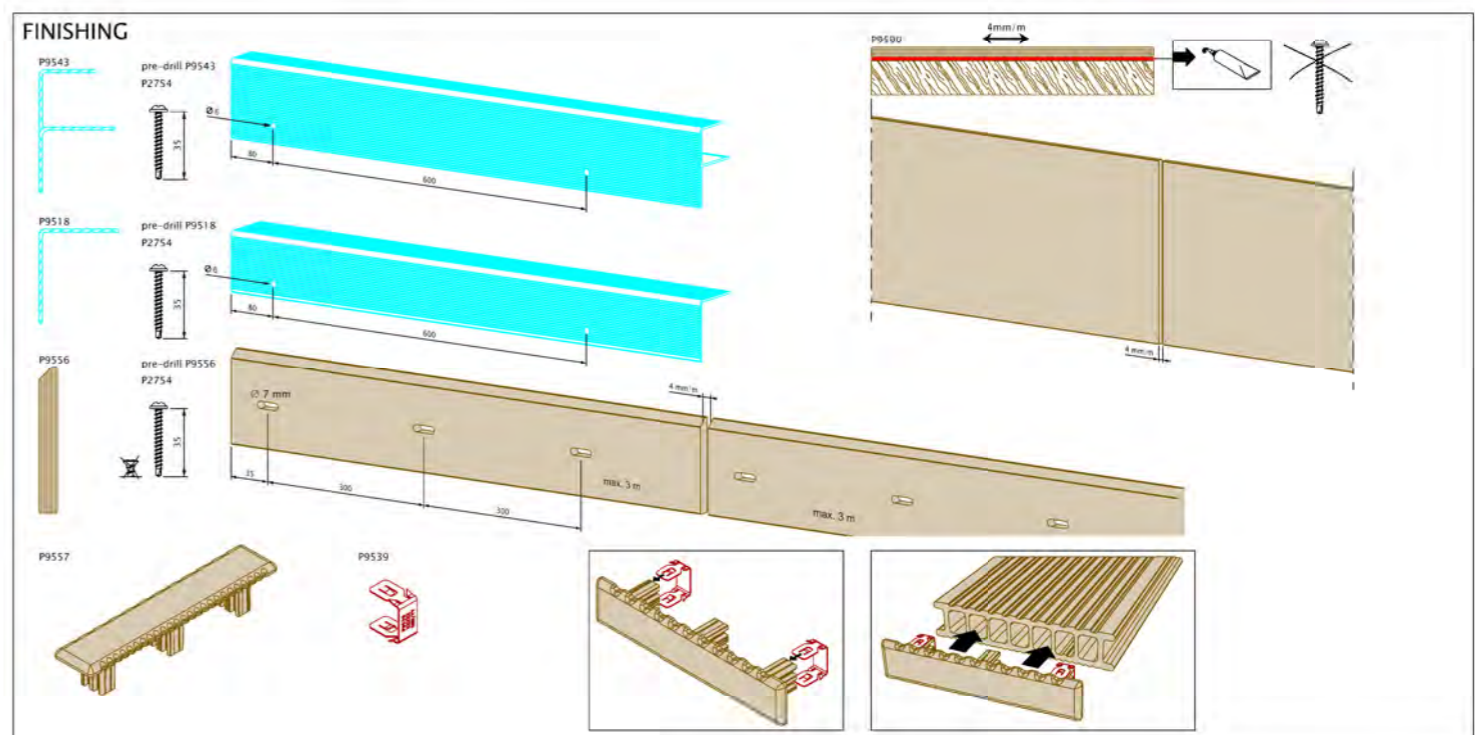
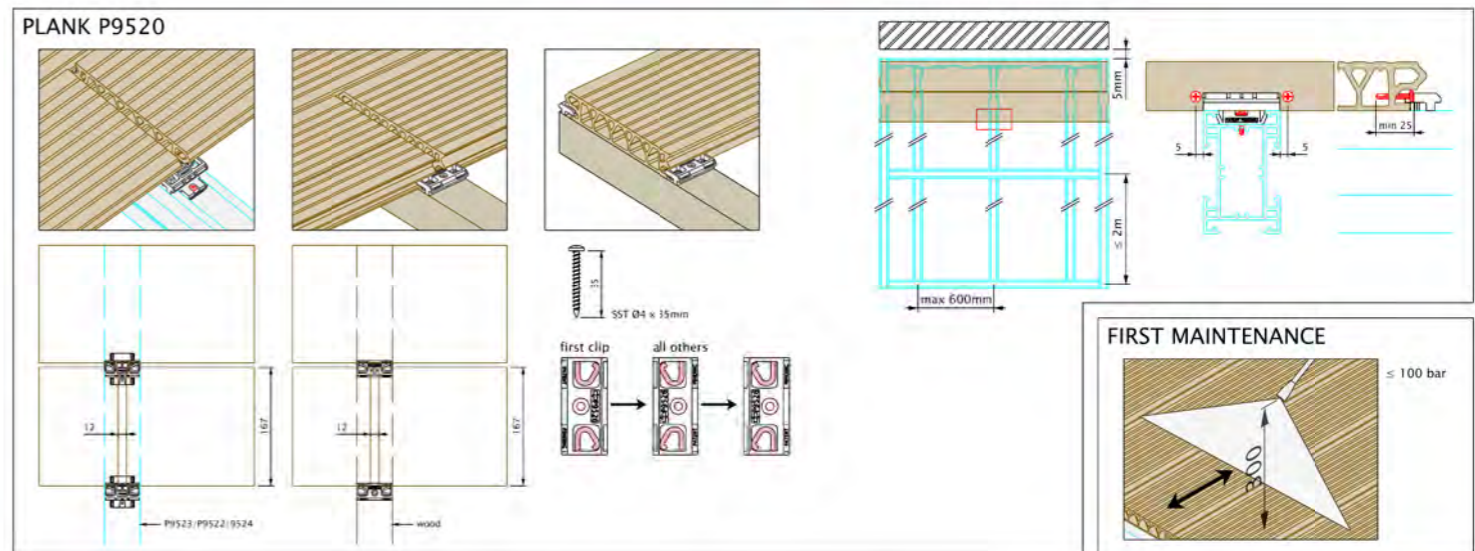
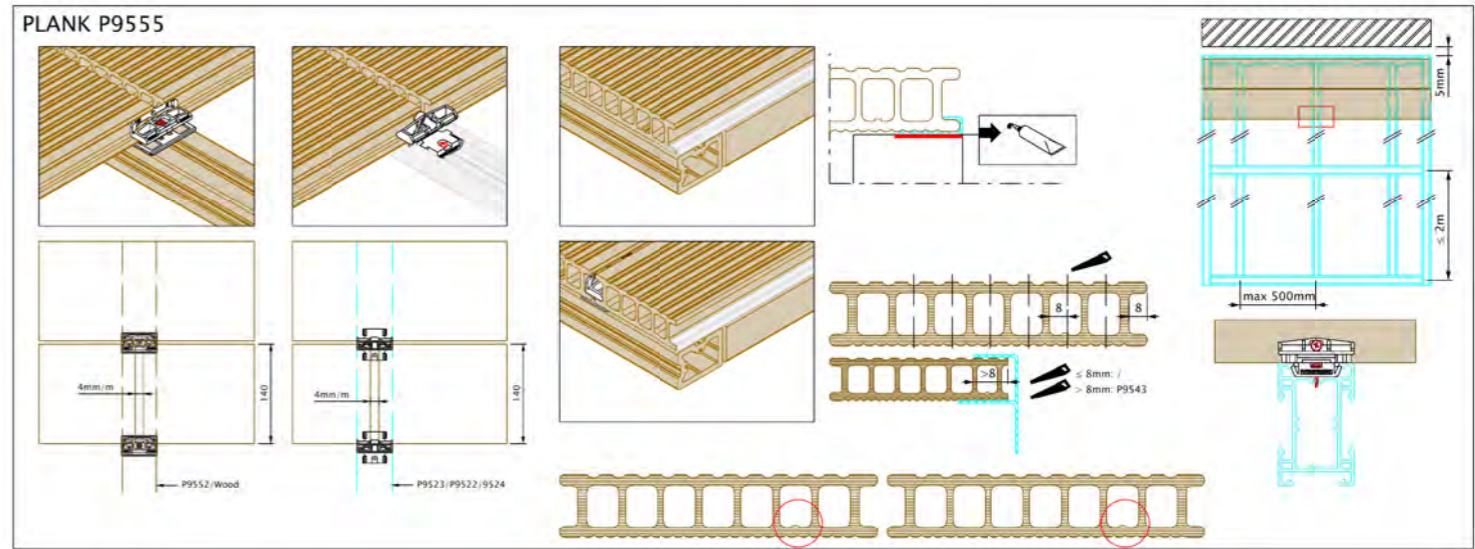
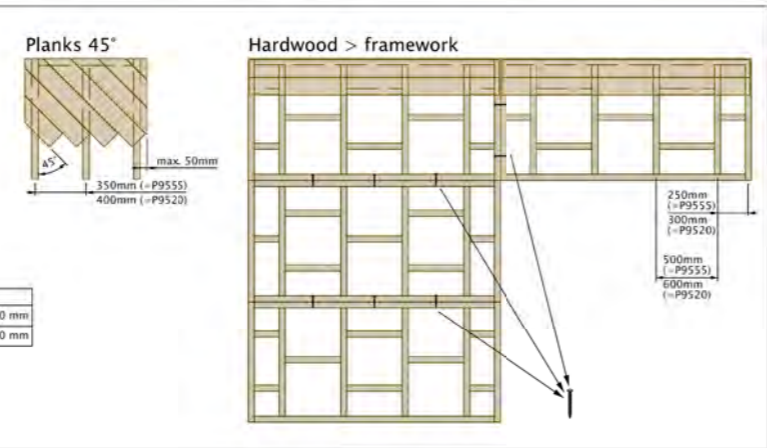
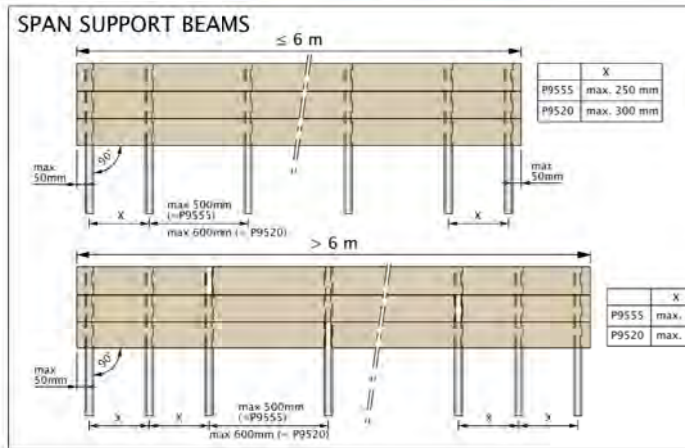
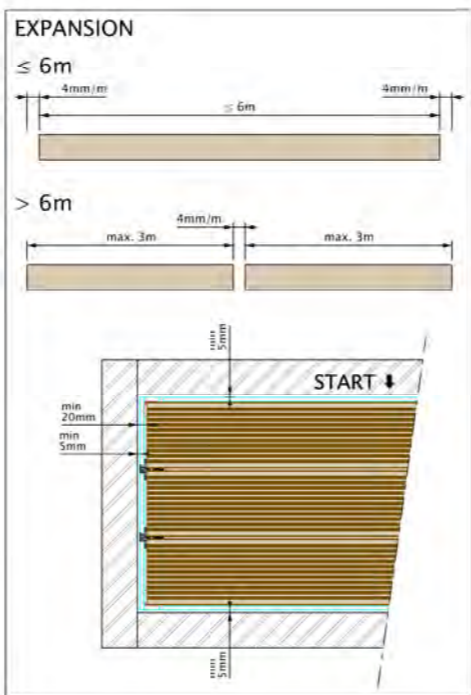
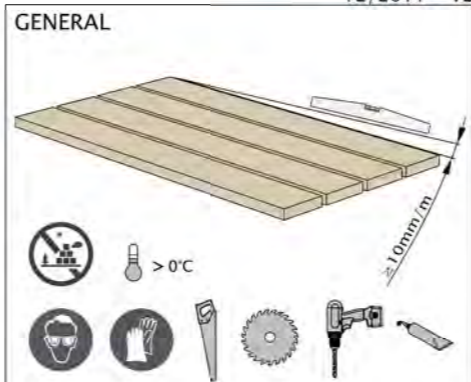
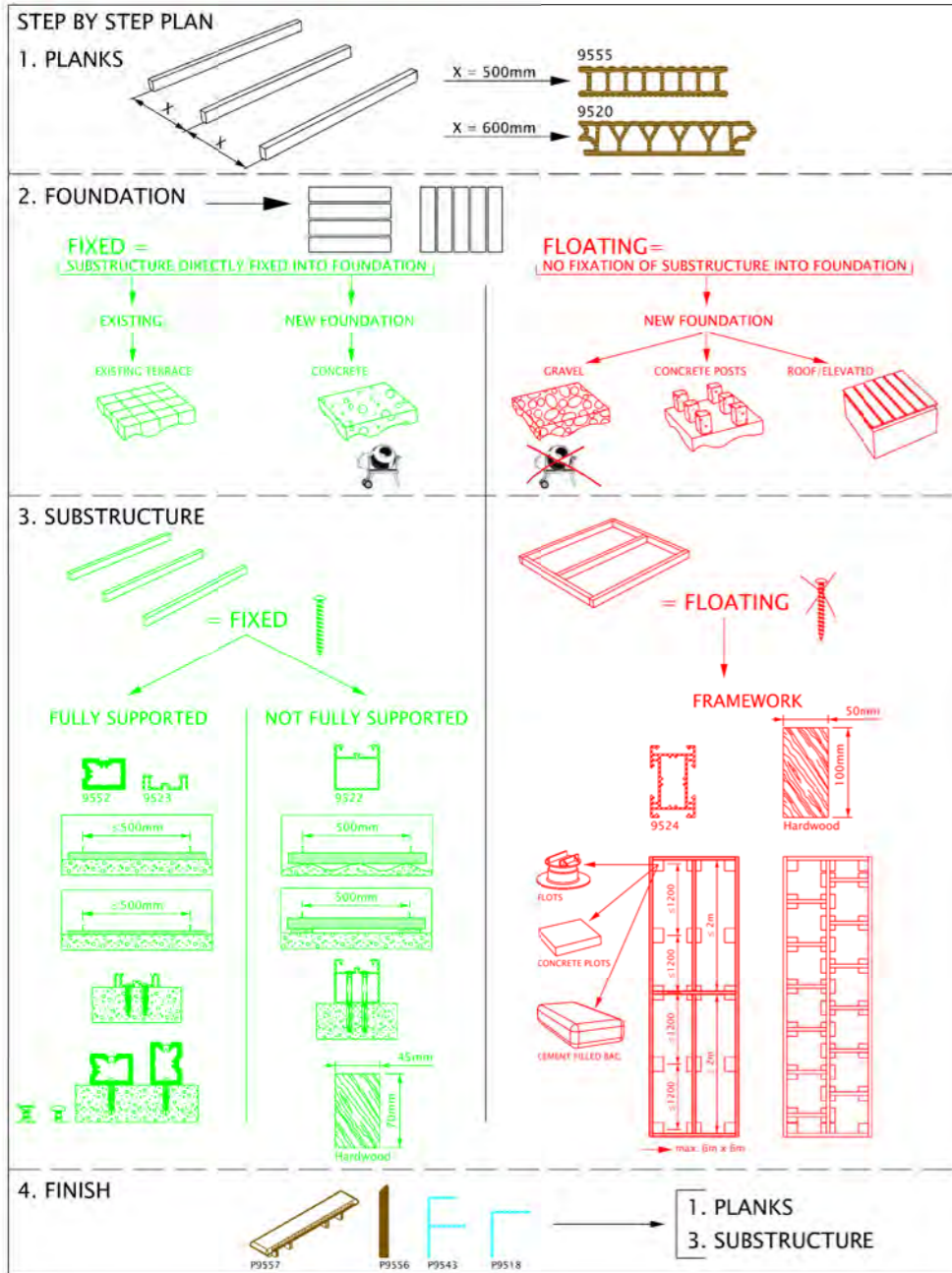

12/11 82048 - 9000 - 8140 V2 PUBLISHED WORK © 2011 - DECEUNINCK  
THIS DOCUMENT CONTAINS PROPRIETARY AND CONFIDENTIAL INFORMATION. DO NOT COPY OR DISCLOSE THIS INFORMATION WITHOUT THE EXPRESS WRITTEN CONSENT OF DECEUNINCK.  
DECEUNINCK RESERVES THE RIGHT TO CHANGE THIS DRAWING AND ANY ASSOCIATED DOCUMENTS.  
© ALL RIGHTS RESERVED